

UNIVERSITY OF ROCHESTER

Design Description Document

DUV SP1

Zachary Evans, Jacob Milberger, Weston Moore

Customers: Pete Kupinski, Optimax Systems, Inc.
Engineers: Zachary Evans, Jacob Milberger, Weston Moore
Advisor Committee: Wayne Knox, UR Institute of Optics

Document Number: 005

Revision Level:
D

Date:
4/17/2016

This is a computer generated document and the electronic master is the official revision. This paper copy is authenticated for the following purpose only:

Authentication Block



The project vision is to create a design study report that gives background knowledge and understanding of current spectrophotometers as well as possible design starting points for a spectrophotometer that can accurately measure broadband spectral reflectivity of an optic for the purpose of evaluating coating deposition uniformity.

Contents

Project Description.....	3
Report Outline.....	3
Handbook to Spectrophotometer Design	3
Cost Performance and Methods of System Performance Estimation	4
Initial Testing of Systems	4
1. Filmetrics small scale testing results.....	4
2. Small scale testing set ups.....	4
Report Section Descriptions	5
Handbook to Spectrophotometer Design	5
Cost Performance and Methods of System Performance Estimation	5
Initial Testing of Systems	5
Photon Budget.....	5
System Block Diagram	6
UV Safety Concerns	6
Examined Designs: Modeling Results	7
Design 1 “Off-Axis” Design.....	7
Double Pass Design	10
Positioning Error of Soft Focus vs. Hard Focus Designs.....	13
Summary of CODE V Analysis:.....	14
Photon Budget Calculation	17
Small Scale Testing.....	17
Appendix A.....	20
Beam Splitter	20
Design 2 “Beam Splitter” Design	21
Polarizer.....	22
Integrating Sphere Design.....	23
Appendix B.....	25
Product Information:.....	25

Project Description

Optimax Systems Inc. has sought out assistance from the Institute of Optics undergraduate class of 2016 in an R&D effort to develop a spectrophotometer for internal metrology purposes. Team AR has been chosen for this project and has been tasked with carrying out a design study to give the engineers at Optimax a head start in their research. The application for this spectrophotometer will be to characterize anti-reflectance coating performance for spherical optical elements. These optics will be both concave and convex and their radii of curvature will range from -70mm to -300mm and 70mm to 300mm. Currently, Optimax is only able to test flat witness samples with non-contact methods rather than the actual delivered optic. This leaves uncertainties for off axis performance of the coatings and if given the ability to measure their product, Optimax would have an advantage over competitors.

Design challenges include angles of incidence on the optic, line scanning for multiple measurements across the clear aperture of the optic, and large spectral band requirements. The spectrophotometer in question will need to perform from 190-500nm. This limits available materials due to absorption and introduces many additional challenges with this project. The line scanning device will be designed by a senior design class in the mechanical engineering department. Their task is to create a mount for optical elements that would be able to keep the optic normal to the optical axis of the spectrophotometer as well as align the optic to multiple points of measurement across the clear aperture. These challenges as well as other specifications are outlined in Document 001 – Product Requirements Document.

Report Outline

Handbook to Spectrophotometer Design

1. Outlining terms, definitions, and variables which will be most important in the report
 - a. Radiometric quantities
 - b. Etendue, what does it mean and how is it used in the report
 - c. Dispersive element, any element in the spectrometer which is used to break up the spectral composition of light.
 - d. Unit under test (UUT)
 - e. Etc...
2. Conventional Spectrophotometer design:
 - a. Photon budget considerations (etendue calculations and equations)
 - b. Monochromators vs. Polychromators
 - c. Conventional dispersive elements
 - i. Prisms
 - ii. Diffractive Gratings
 - d. Conventional light sources, point sources and extended

- i. Compare brightness values, power output, etendue, etc...
 - e. Coupling a light source to a spectrometer
 - f. Detectors
 - i. Photomultiplier tubes
 - ii. Semiconductor Power detectors
 - iii. CCDs
 - iv. NEP calculations
- 3. Novel Spectrophotometer design:
 - a. Discussion of how this design differs from existing spectrophotometers, and how the fact the design must take into account the curvature of the UUT affects the possible solutions.
 - b. Research into patents and published novel spectrophotometer designs is required
 - i. Spectrophotometers for curved surfaces
 - ii. Reflection spectrophotometers
- 4. Designs which will be detailed in the report
 - a. Simple off axis design
 - b. On axis, beam splitter design
 - c. Complex design (polarization design)

Cost Performance and Methods of System Performance Estimation

1. Analysis of detectors which are available, PMTs, CCDs, etc...
 - a. Calculations of NEP for sensors
2. Analysis of researched sources, and which ones work for each design
 - a. Using the previous NEP calculations for the sensors, complete a first order analysis of which sources discussed in chapter 1 part 2c could potentially work in this spectrophotometer
3. Further analysis of components which could be used in the system and how they will act to attenuate the throughput of the system
4. Methods of modeling the effect of the components on the system

Initial Testing of Systems

1. Filmetrics small scale testing results
 - a. Reflectance results compared to expected reflectance measurements
 - b. Measured film thickness
2. Small scale testing set ups
 - a. Initial concerns of small scale test set ups
 - b. Diagrams of tests
 - c. Filmetrics Products used in testing

Report Section Descriptions

Handbook to Spectrophotometer Design

The purpose of this section of our report will be to give a basic overview and understanding of the various components of a spectrophotometer. In addition to this it will define and characterize terminology and common phrases used in optical design and spectroscopy. This is incredibly important for any designer who carries out the rest of the system design after this project is handed over to Optimax. The hope is that this section will give a framework to work within to avoid chasing dream designs that would be unrealistic or impractical. There are very well established designs that would allow for existing geometries and layouts to be utilized in this new design. This section of the report will also include example etendue calculations to assist with the photon budget.

Cost Performance and Methods of System Performance Estimation

This section of the report will outline the various designs and components to establish an idea of the cost to performance benefits between the different component and design options. We will establish what we believe the best designs are based on existing spectrophotometers as well novel ideas that we have come up with. This section may prove to be the most valuable for Optimax due to the budget considerations partnered with the system specifications and desired performance. We hope to be able to give many options with the various possible configurations and their corresponding capabilities outlined thoroughly.

Initial Testing of Systems

We have learned that the calibration of our device does not hinge upon characterizing every individual component, but rather an initial calibration of the entire system will be sufficient. This was exhibited to us in our first visit with Filmetrics, a local company that specializes in spectrophotometer design and thin film measurement. This section of the report will outline the process for initial testing and system calibration. This may end up being driven by software depending on the design chosen, however it will be outlined in the event that a more custom system is developed.

Photon Budget

When considering the photon budget for this project there are two main limiting factors we must consider: the etendue of the optical system and the Noise Equivalent Power (NEP) of our detector. In this case we have found that the NEP for our detector is effectively 5pW. The etendue of our system will more than likely be limited by the etendue of the coupling fibers used. We have many different designs we need to study in depth and this will play into our cost performance analysis section of our report. The photon budget will be included in this as well. Designs with preferred performance will have a more effective photon budget and will decrease our Signal to Noise Ratio (SNR).

System Block Diagram

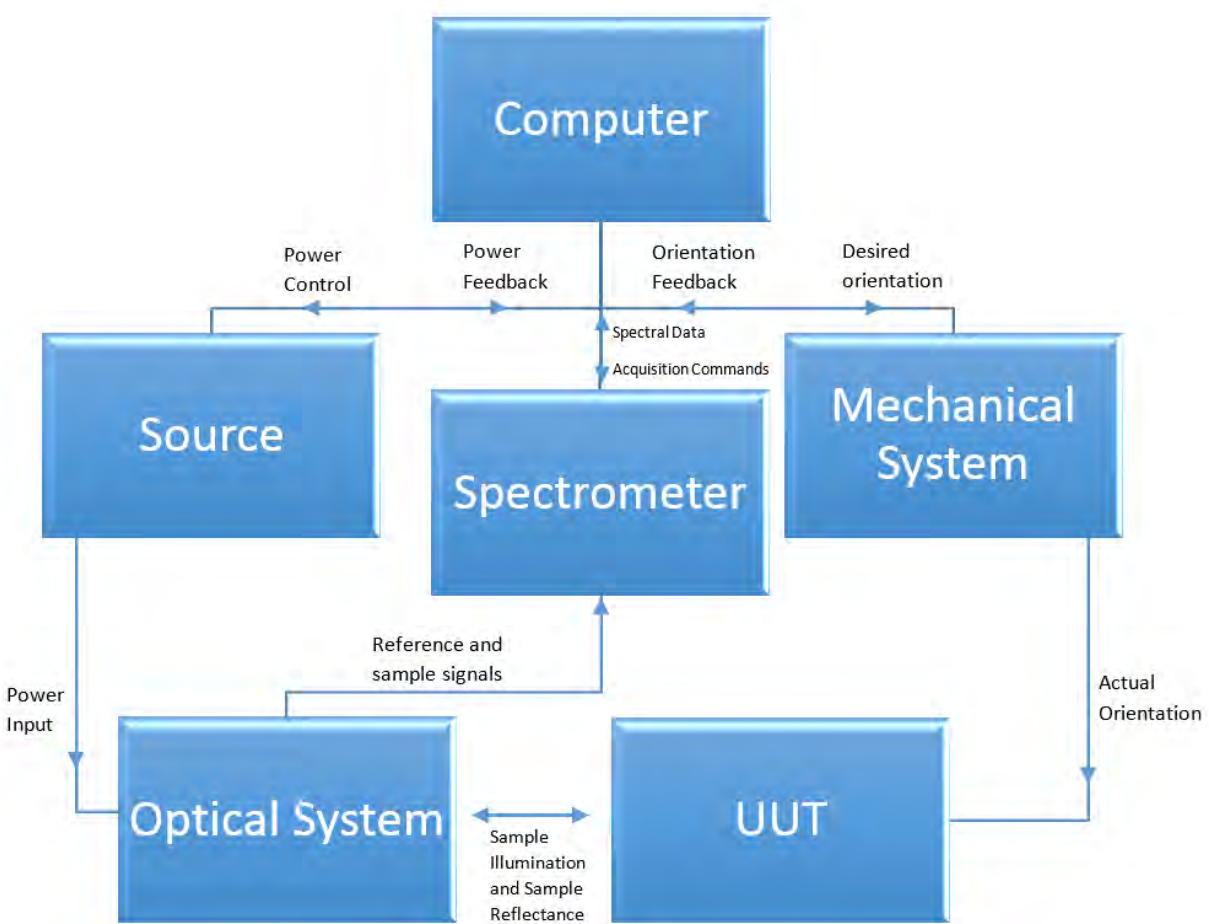

UV Safety Concerns

The negative effects of UV radiation are often times not seen right away. This is a concern because the operator could be doing damage without knowing it. There are currently no specific protocols for the UR in regards to the safe use of UV radiation. As a result of this it is simply recommended to use well known best practices for reducing stray light from systems using UV radiation. This includes but is not limited to using light shields, enclosures, and curtains. We intend on enclosing our system should we do any lab testing of sources that emit UV radiation. Another thing to consider is that a high powered UV source should not be focused in an environment containing O₂ due to ionizing which will produce ozone. If focusing a high powered beam of light is necessary it is recommended to use a nitrogen purge for safety.

Examined Designs: Modeling Results

Design 1 “Off-Axis” Design

Off-axis Design sensitivity to vertical position errors

	0mm position error	5mm position error	10mm position error	35mm position error	45mm position error
70mm	96.7uW	95.8uW	91.7uW	27uW	6.9uW
100mm	152.6uW	144uW	133uW	53uW	20uW
200mm	313.8uW	296uW	274uW	160uW	97uW
250mm	400uW	356uW	338uW	213uW	150uW

Table 1: Sensitivity of the Off-axis design to scanning system z-axis position errors. Left column consists of radii values for the UUT. Top rows consists of the positioning error. The system is extremely insensitive to position errors. Note that these values were acquired using 1000 rays, and thus are not accurate to actual collected reflected light.

Off axis Design sensitivity to horizontal position errors

	-0mm position error	-1mm position error	-2mm position error	-3mm position error	-4mm position error
70mm	96.7uW	90uW	78uW	88uW	78uW
100mm	152.6uW	164uW	158uW	147uW	156uW
200mm	313.8uW	152uW	432uW	485uW	517uW
250mm	400uW	452uW	536uW	614uW	685uW

Table 2: Sensitivity of the interferometer design to scanning system x,y-axis position errors. Left column consists of radii values for the UUT. Top rows consists of the positioning error. The system is extremely sensitive to horizontal positioning errors.

Off axis Design Power Collection sensitivity to UUT Radius

	Power collected
70mm	96.7uW
100mm	152.6uW
200mm	313.8uW
250mm	400uW

Table 3: The power collected at the collection plane does vary based on the radius, however this is most likely due to the some sort of error in the model, or back reflection from the rear surface of the sphere in the model. Further, the change would be far less in the real spectrophotometer since our spectrum of interest is only about a third the width of the modeled spectrum.

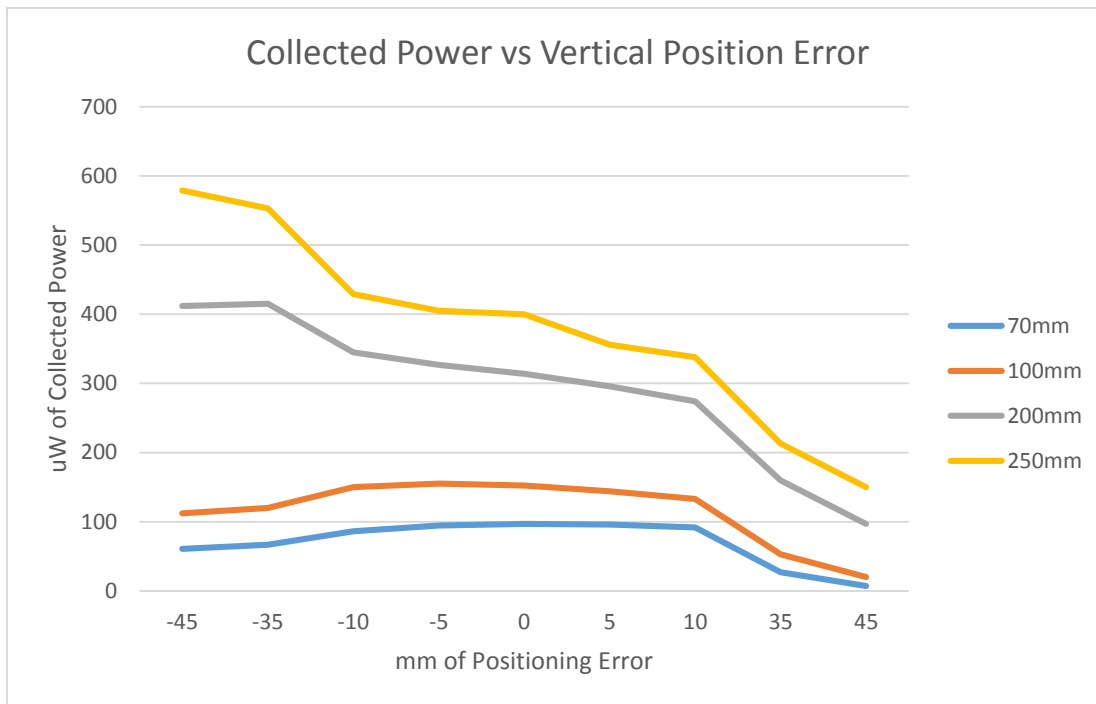
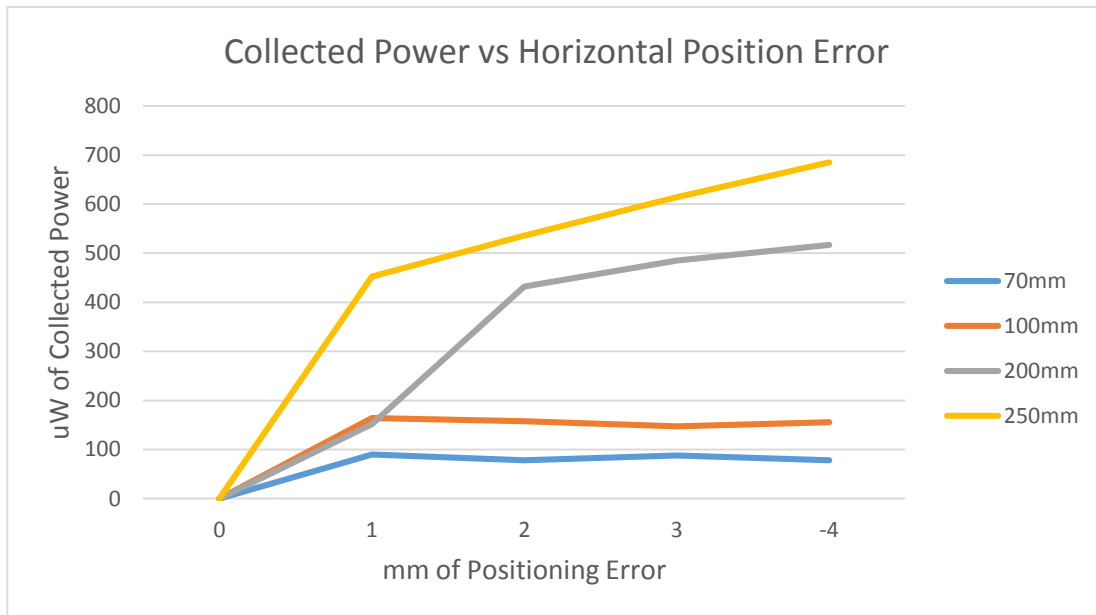

While this design offers the beauty of simplicity, it does not offer the ability to counteract diverging reflected rays. It can be seen in the above plots and data that this design is extremely sensitive to positioning errors. In the data above it is seen that even a positioning error of +/- 5mm in either the transverse or inline axis causes a detrimental amount of change collected power.

The further addition of a beam condenser could improve the results of this system since the smaller the incident beam, the less beam divergence will occur. The tradeoff however, is that the smaller the beam is made, the more angular extent it will take up, and thus the beam can only

be condensed to a certain point before it fills more than 4 degrees. This effect is especially dramatic because the light incident on the UUT is already non-normal. A beam condenser is further limited by the fact that it would only work for a range of UUT radii, the smaller the radii of the UUT, the more reflected light will diverge, and the more light will miss the collection optics even with a beam condenser.

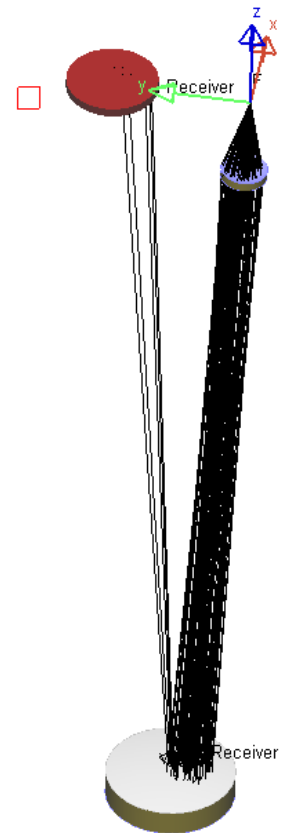
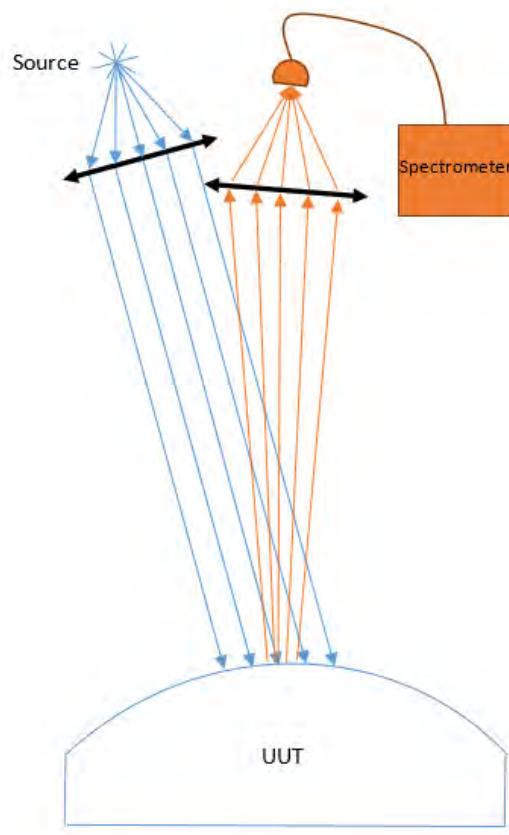

System Components

- Source
- Collimator
- UUT
- Coupling Lens
- Detector

Double Pass Design

Design modeled off of the geometry of an interferometer. The goal is to align the focal point of the illumination system with the center of curvature of the UUT.

Interferometer Design sensitivity to vertical position errors

	-0mm position error	-5mm position error	-10mm position error	-35mm position error	-37mm position error
70mm	1.062uW	1.062uW	1.062uW	1.062uW	1.0522uW
100mm	1.062uW	1.062uW	1.062uW	1.062uW	1.062uW
200mm	1.062uW	1.062uW	1.062uW	1.062uW	1.062uW
250mm	1.062uW	1.062uW	1.062uW	1.062uW	1.062uW

	0mm position error	5mm position error	10mm position error	35mm position error	37mm position error
70mm	1.062uW	1.062uW	1.062uW	1.062uW	1.062uW
100mm	1.062uW	1.062uW	1.062uW	1.062uW	1.062uW
200mm	1.062uW	1.062uW	1.062uW	1.062uW	1.062uW
250mm	1.062uW	1.062uW	1.062uW	1.062uW	1.062uW

Table 4: Sensitivity of the interferometer design to scanning system z-axis position errors. Left column consists of radii values for the UUT. Top rows consists of the positioning error. The system is extremely insensitive to position errors. Note that these values were acquired using 1000 rays, and thus are not accurate to actual collected reflected light.

Interferometer Design sensitivity to horizontal position errors

	Power collected
70mm	3.217uW
100mm	3.2337uW
200mm	3.2458uW
250mm	3.2459uW

Table 6: The power collected at the collection plane does vary based on the radius, however this is most likely due to the some sort of error in the model, or back reflection from the rear surface of the sphere in the model. Further, the change would be far less in the real spectrophotometer since our spectrum of interest is only about a third the width of the modeled spectrum.

Interferometer Design Power Collection sensitivity to UUT Radius

	-0mm position error	-1mm position error	-2mm position error	-3mm position error	-4mm position error
70mm	1.5032uW	1.5032uW	1.5014uW	0.61094uW	0.60404uW
100mm	1.5032uW	1.5032uW	1.5032uW	1.5028uW	0.61094uW
200mm	1.5032uW	1.5032uW	1.5032uW	1.5032uW	1.5032uW
250mm	1.5032uW	1.5032uW	1.5032uW	1.5032uW	1.5032uW

Table 5: Sensitivity of the interferometer design to scanning system x,y-axis position errors. Left column consists of radii values for the UUT. Top rows consists of the positioning error. The system is extremely sensitive to horizontal positioning errors.

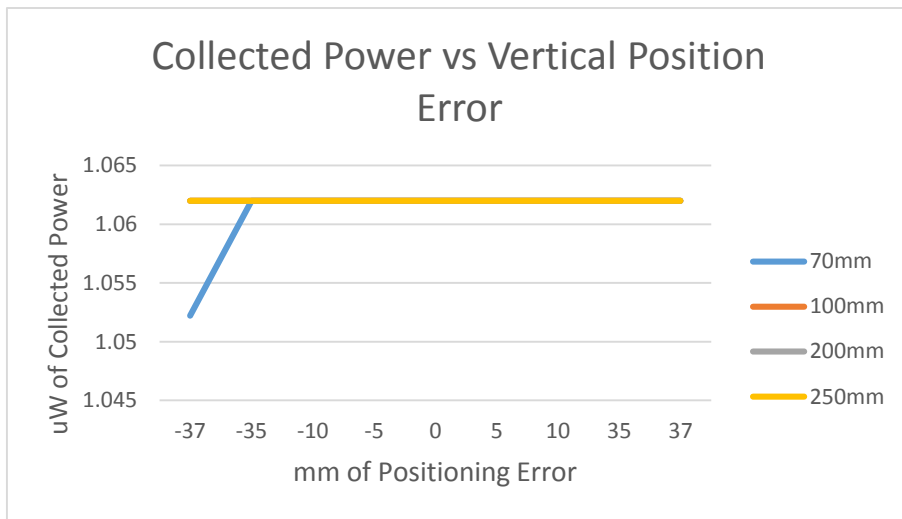
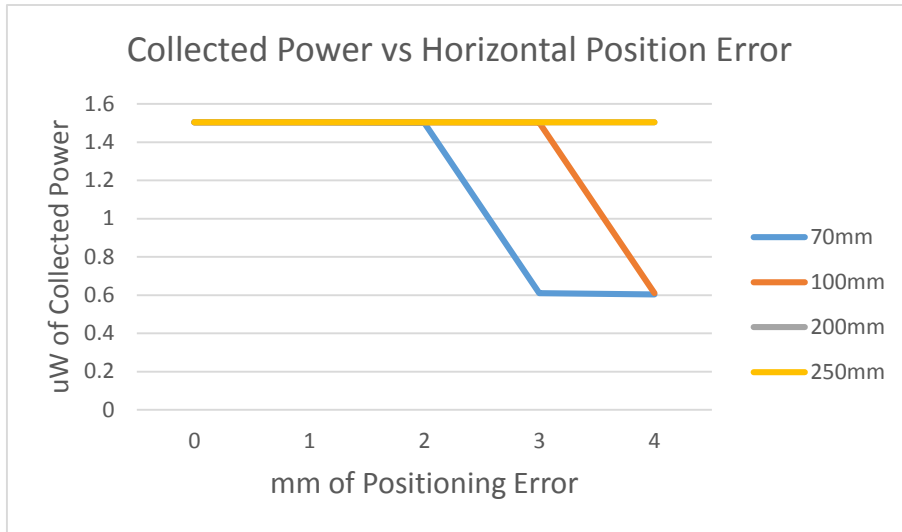

This design is able to remain insensitive to defocus position errors (those errors which move the UUT on axis with the axis of the system. This is because the focusing of the light decreases the detrimental effects of diverging reflections off the UUT. In the Off axis design in contrast, any motion of the UUT causes light reflecting from its surface to diverge and miss the collection optics. In a spectrophotometric system, this kind of failure to collect light cannot be accounted for in the final results and should therefore be avoided as much as possible.

This design is still sensitive to horizontal positioning errors (errors in aligning the optic on a plane transverse to the optical axis), however. The converging light in the focusing beam cannot account for this change in curvature, and misses the collection optics just as they do in the off-axis design. Further, horizontal position errors would have the potential to negate the positive aspects of this design. Since this design is focused on returning only light which was normally incident, or nearly normally incident, a transverse position error would negate this effect, and return non-normally incident rays. The effect is somewhat muted since light loss due to missed rays would overwhelm the non-normal data, however it should be noted nonetheless.

Optical Layout Drawing

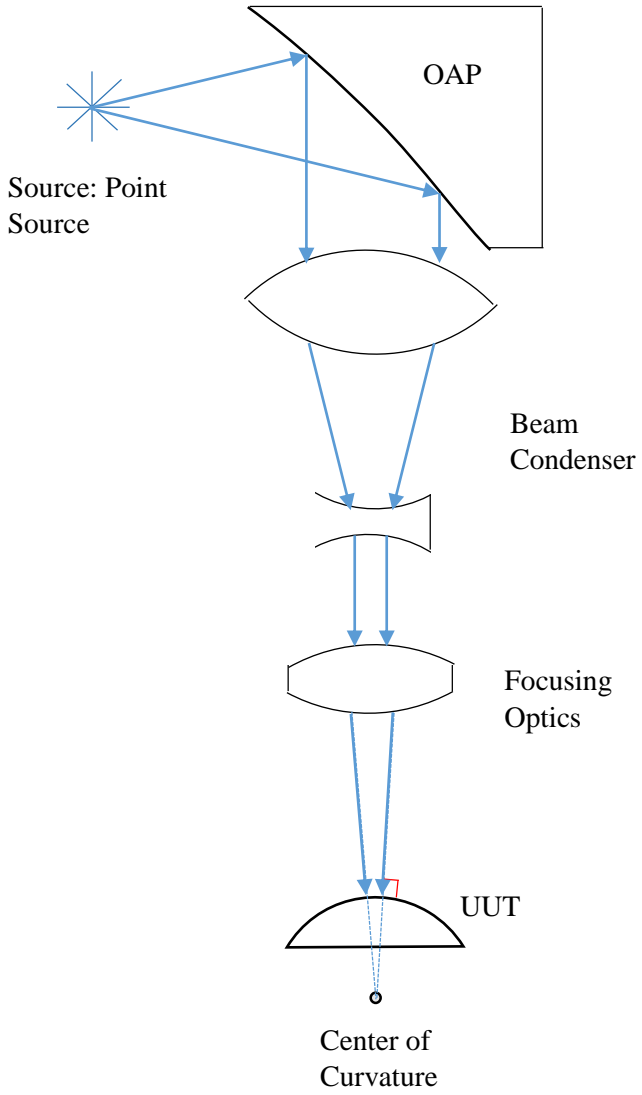

Light Tools Model

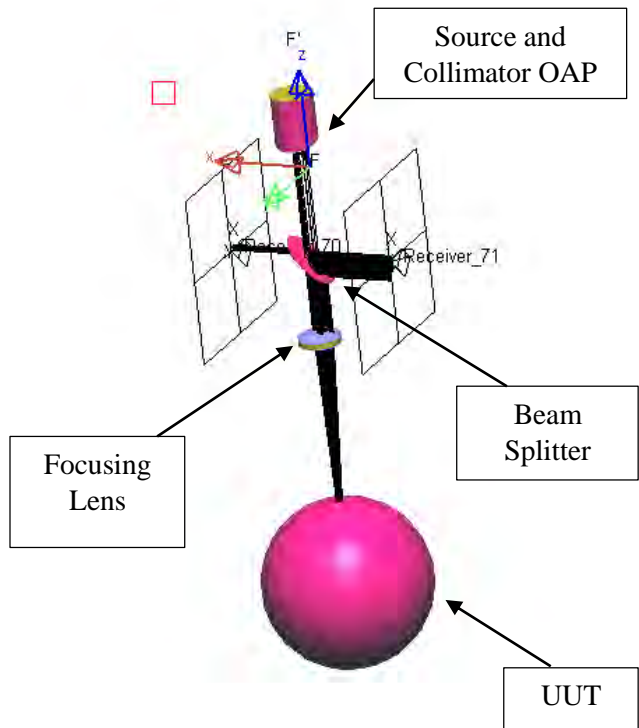

Positioning Error of Soft Focus vs. Hard Focus Designs

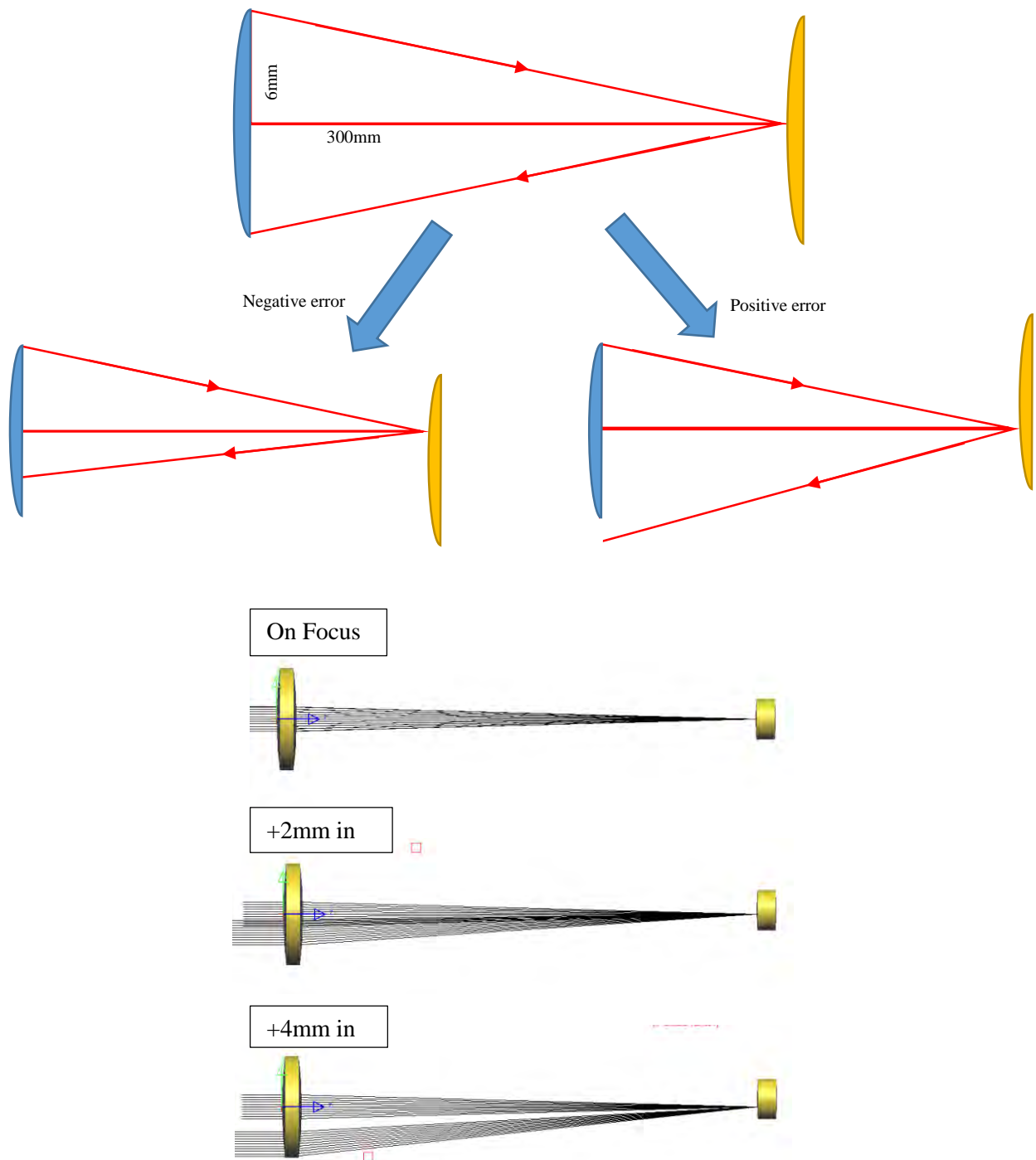

Figure 1: Model of 'hard focusing' design with 2" objective w/ 248mm focal length, and a UUT with a 100mm ROC. Input ray ran: 12mm diameter. Error in positioning of the UUT is extremely detrimental to the functioning of the spectrometer.

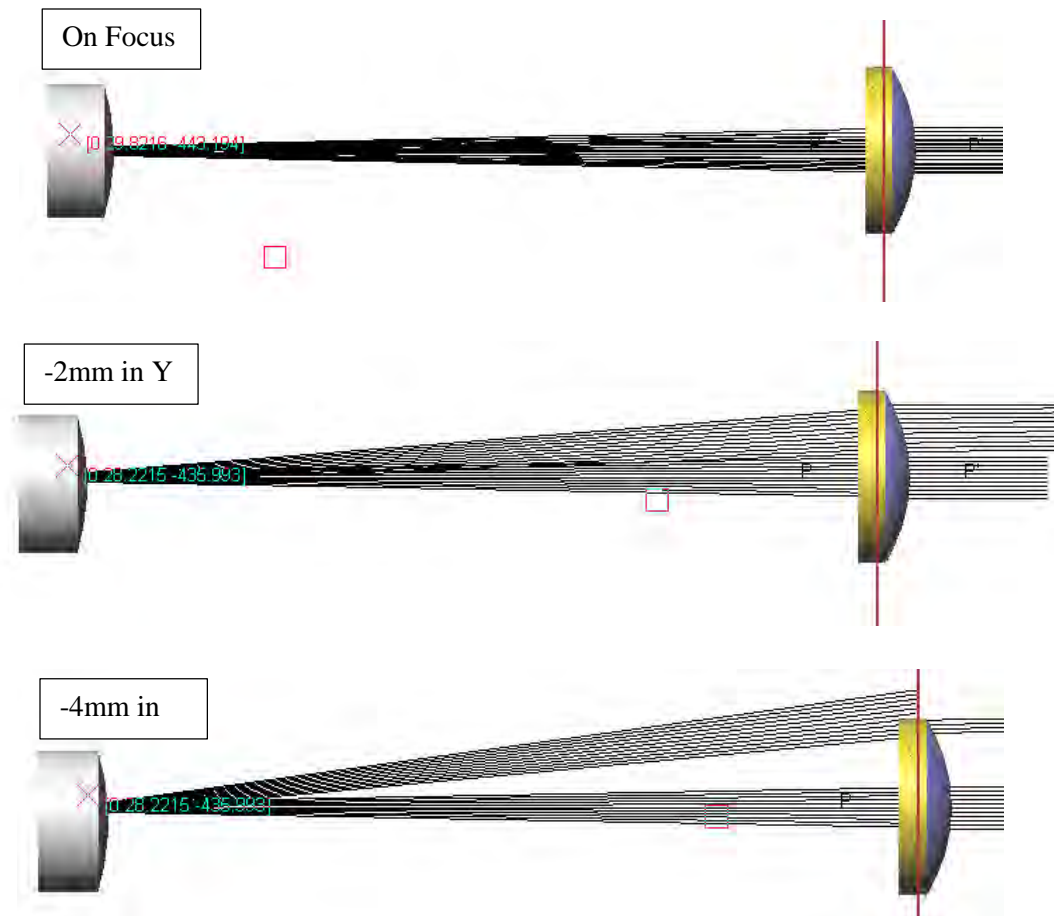

Figure 2: Model of 'soft focusing' design with 2" objective w/ 248mm focal length, and a UUT with a 100mm ROC. Input ray ran: 12mm diameter. Error in positioning of the UUT is extremely detrimental to the functioning of the spectrometer.

Summary of CODE V Analysis:

Initial attempts at CODE V analysis were challenged by the fact that an image plane was not found by the software. The goal was to create a point source relay using a parabolic mirror, a beam condenser, and focusing optics. The purpose of this was to give proof of concept for the "Double Pass" or "Focusing" design. Initially, this was attempted by manually entering various lens parameters vaguely fitting the description listed above. The hope was that the software would clean up the optical layout in the optimization process. This was a poor assumption to make because the system was so heavily weighed down by aberrations that it was impossible to locate an image plane. Beyond this, axial color was well over 100 waves.

This basic analysis taught us two things:

1. Don't assume that your rays are focusing just because the drawing makes it look that way.
2. If you don't have a starting point, you have to do a first order analysis. It's better than stumbling through the software hoping it will magically fix things.

See the initial setup progression below:

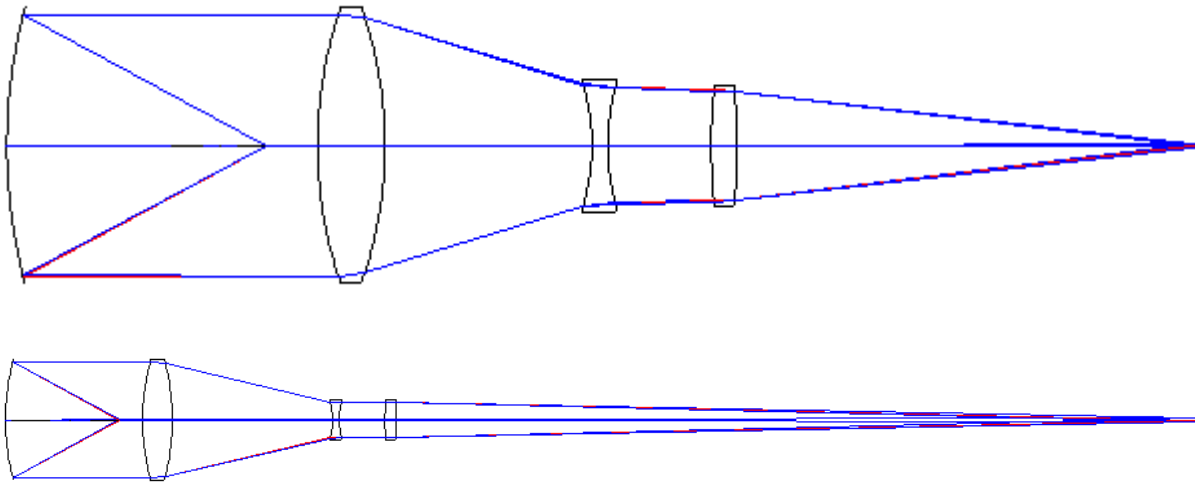

The image plane was located by manually entering a position based on the drawing shown by CODE V. This was misleading because these single points didn't show the terribly large amounts of spherical and coma present in the system. When you draw in the entire ray fan you can see how terrible the system actually is. See below:

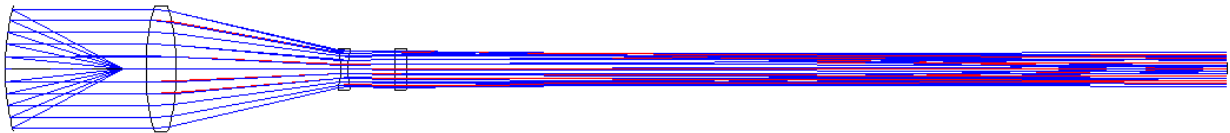

This is the same exact system shown above but with the entire ray fan traced instead of just the marginal and chief rays. The next step was to move into a simpler design starting from a singlet and progressing to an air spaced triplet. Due to the DUV spectrum used, we can't cement our doublets. Doublet cement is UV cured and will not transmit in our spectrum. We are also limited to fused silica and calcium fluoride for material choices. This makes color correction especially challenging in a refractive system. You will also notice that the system has been inverted. This was done by recommendation of Professor Julie Bentley who advised that the tracing would work best if the airspaces were negative after the reflecting surface. Also, the initial setup didn't have the on axis field point as the first field in the system preferences. This is a subtle mistake that was corrected, but it is very important for proper use of the software. The preliminary results are shown below:

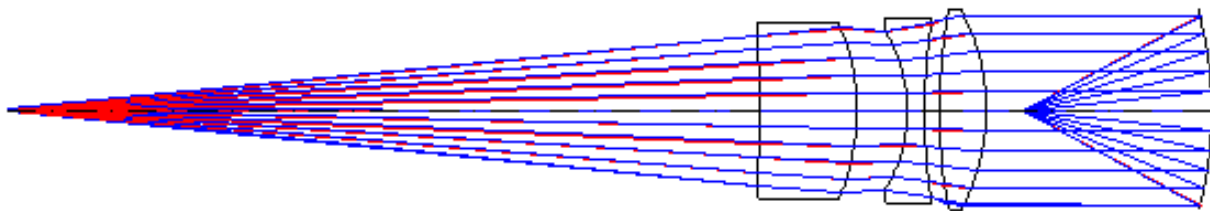

This design was made quickly to develop a better starting point for future analysis, should we continue CODE V modeling of a refractive design. We may find that the custom optics we develop are the same as the UV corrected triplet we've been looking at online. The major difference between the design above and the UV corrected triplet online is the shape of the third lens. This lens' shape is to correct the coma introduced by the parabola at off axis positions. See the RIM plots below and note the large amount of axial color and off-axis coma.

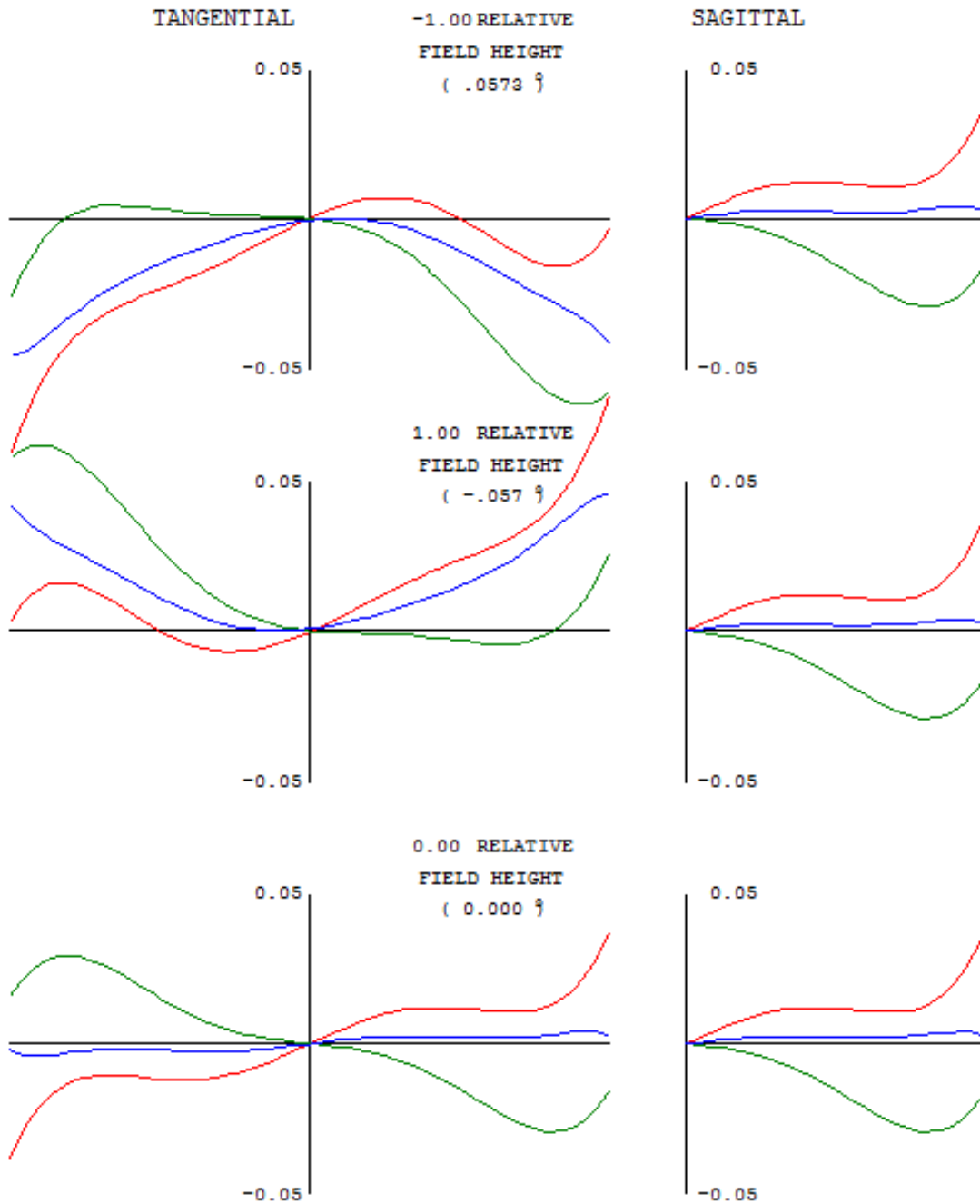

Another thing to note is that we don't have the tilts and decenters necessary for the off axis design that we would use. This will affect the coma present in our design as well as other aberrations. Moving forward we need to be aware of a few things:

1. Color correction across the DUV will be very challenging with a refractive design.
2. A reverse Schwarzschild objective is what we want to use. See the photo below, the Schwarzschild has a low NA side and a high NA side. We need to either design a custom Schwarzschild that is effectively in reverse or take a normal Schwarzschild and put it in a fixture backwards to relay light from a fiber to the UUT.
3. Should we design a custom objective, we need to know the incoming light specifications from the Filmetrics system. It may be most sensible to forego the use of the Filmetrics system and simply flip around a COTS Schwarzschild objective to relay a fiber coupled source to the UUT.

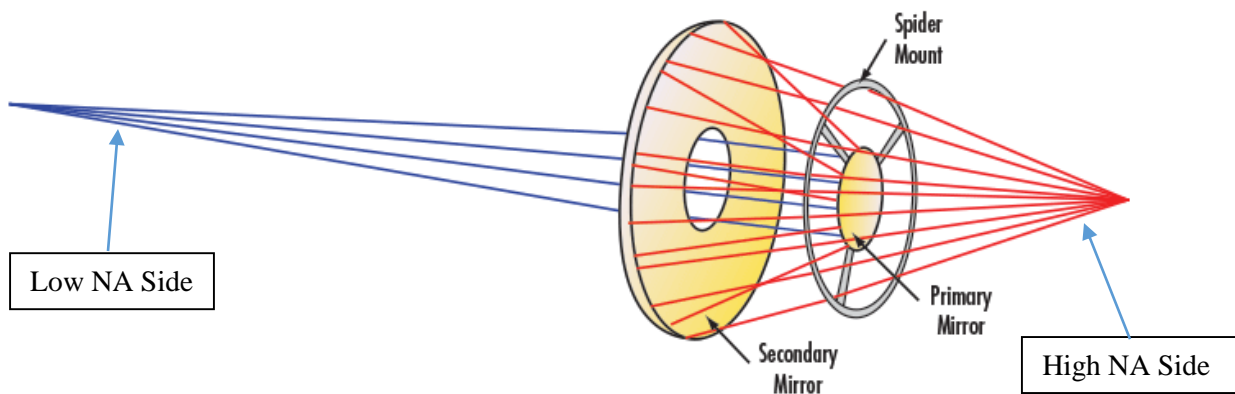

Source:
<http://www.edmundoptics.com/resources/application-notes/microscopy/introduction-to-reflective-objectives/>

Small Scale Testing

In order to test the viability of the focusing design, it was critical to build a testing platform. The test bench required the flexibility to increase and decrease the inspection NA on the fly, as well as being able to account for the various test optics that Optimax has provided. The test bench in addition needs to fix the various components rigidly so that the alignment is not ruined when the UUT is replaced, or the table is inadvertently struck. Below is a diagram of the initial test set up designed to test the low NA focusing concept.

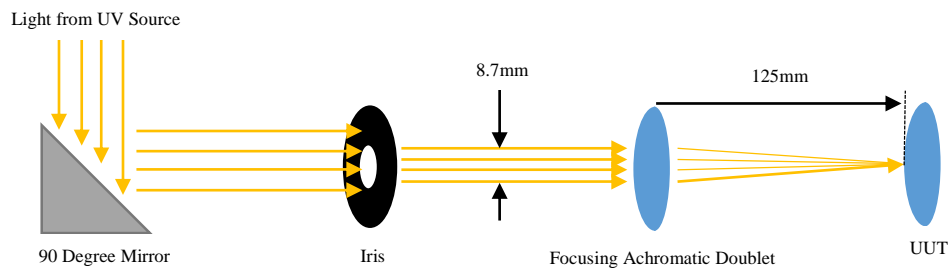

In the diagram above, light from the UV light source is folded into the system using an enhanced aluminum mirror. The light from the light source may be too large, so the next element is an iris

to cut the diameter of the light to the maximum 8.7mm diameter. From there, the light is focused using a focusing objective (in this case we use a UV achromatic doublet from Edmund Optics) on to the UUT. The light is reflected back into the system from the UUT and is measured by the spectrometer. The test bench was built using components borrowed from the Institute, and aligned on a simple optical rail for ease of construction.

After the parts were acquired and the set up built, it was brought to the Filmetrics applications lab in Fairport for testing. There we were able to use their UV spectrometers as well as a Filmetrics Tungsten/D2 lamp to test the viability of the design. Below is a plot of two 5 measurements of the coating under inspection.

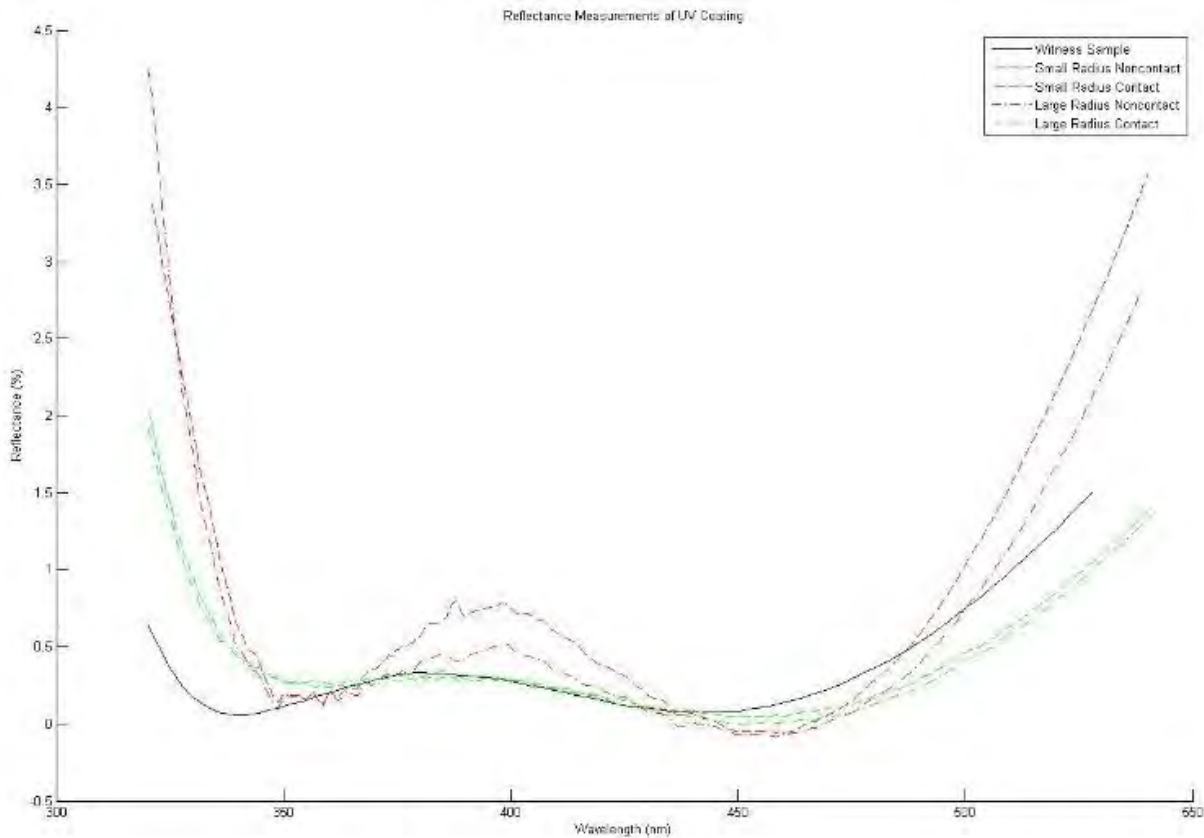

In the figure above the black plot is of the Optimax measurement made on their Perkin Elmer spectrophotometer. The green measurement is using the Filmetrics Contact probe, which Optimax would like to replace. Finally, the red plot is of the measurements using our focusing design. It can clearly be seen that there is a large discrepancy between our measurements and Optimax's measurements. There are a number of issues causing this. The first of which is Filmetrics' aging equipment, their light sources, and calibration standards are well worn, and are in need of replacement or repair. Therefore, it could easily be that the equipment at the lab is not optimum for our purposes. Further, it's possible that the light from the light source is not perfectly collimated as was expected, adding another variable to the measurements.

Due to the errors made in the first set of measurements, the test bench was changed, and a new calibration standard was borrowed from the school. Below is the diagram of the new set up, and data taken from the second set of measurements taken at Filmetrics.

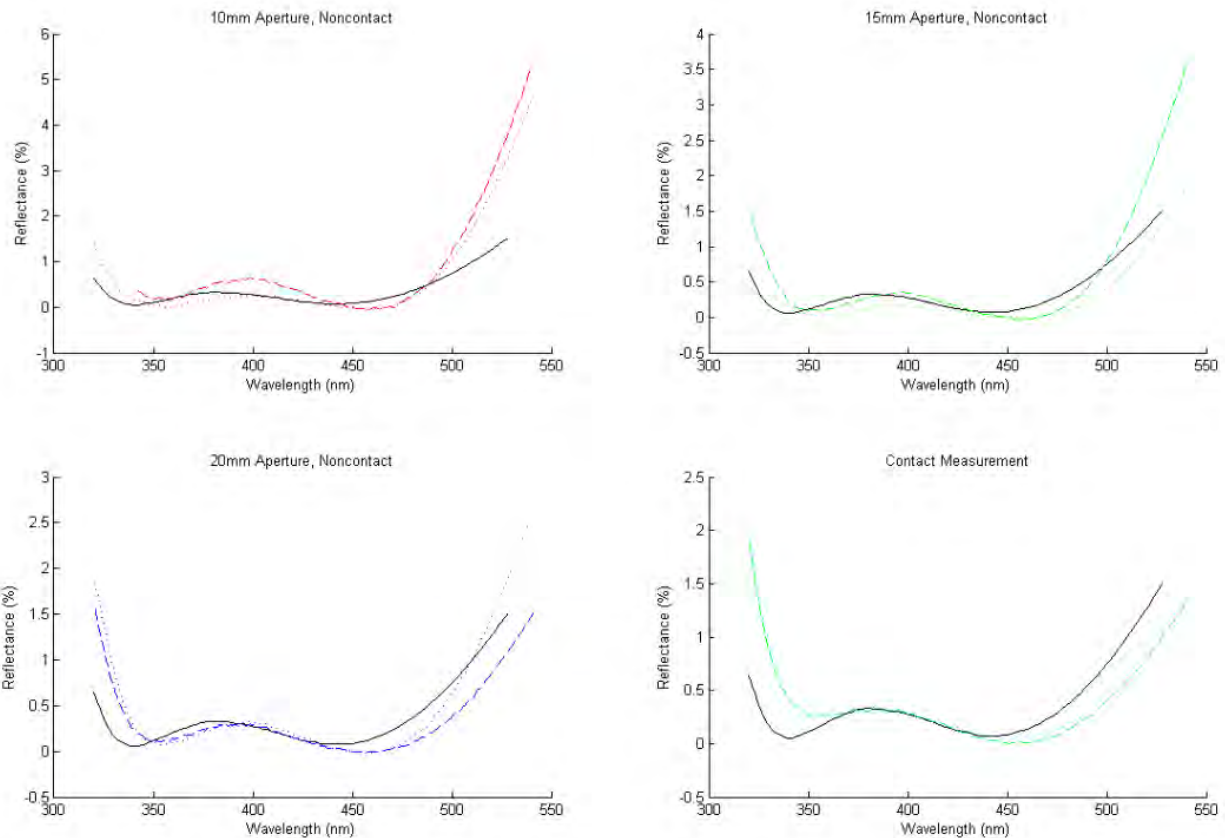
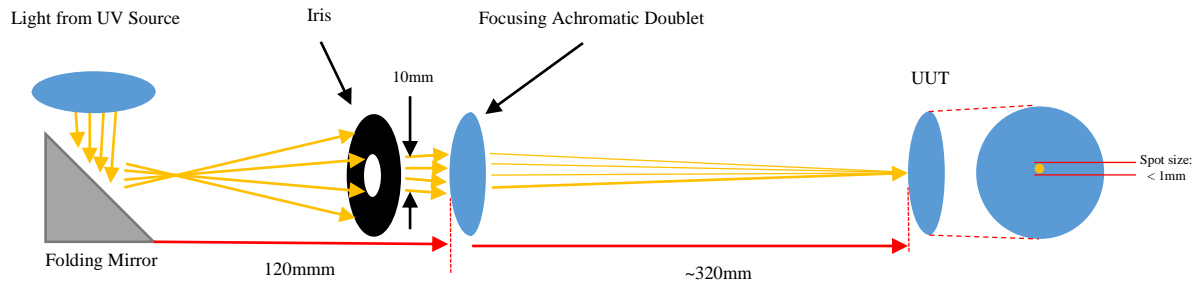

It can be seen that as the aperture diameter is increased, the data taken becomes more accurate. However, as the aperture is made larger, the inspection NA is increased as well, an undesirable outcome. The inaccuracies in the new measurements can be accounted for by the fact that the UUT and the calibration sample are not the same thickness, and by changing them the measurement is being effected, an observation supported by the fact that the small and large radius measurements are not the same in the noncontact trials.

The report will note any ways that the measurement procedure can be improved, or any common errors which could be made when aligning the system.

Appendix A

Previous Design Concepts:

Beam Splitter

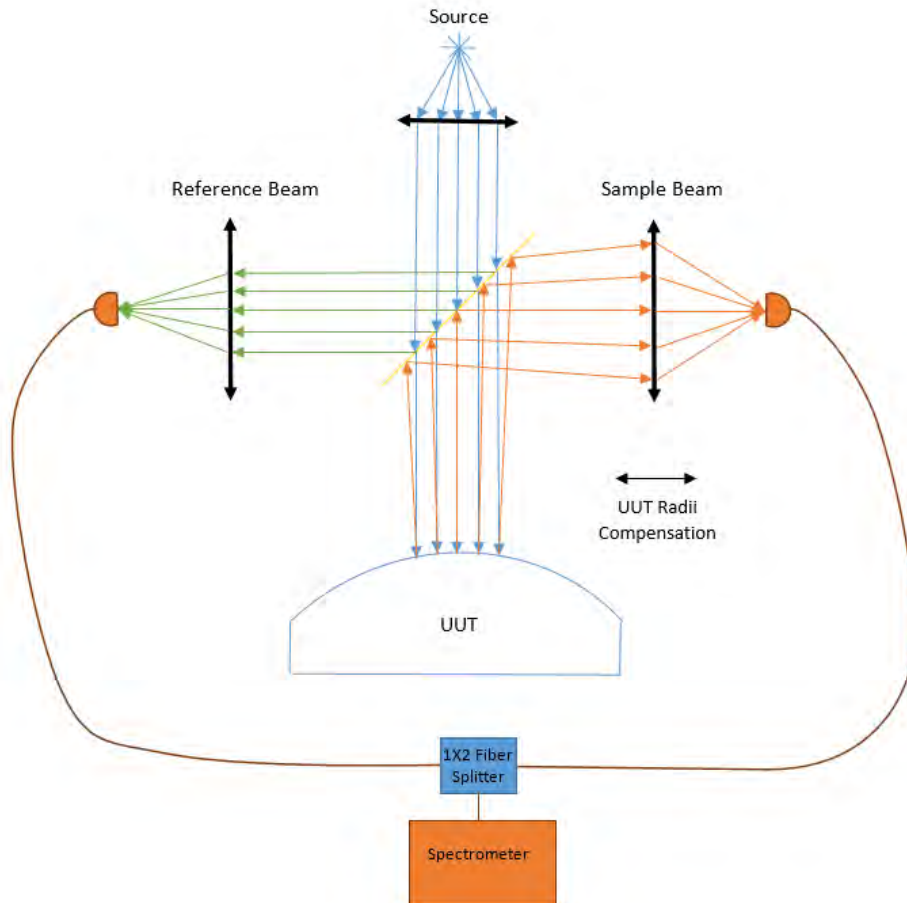

System Components

- Source
- Collimator
- Beam Splitter
- UUT
- Coupling Lens (reference)
- Coupling Lens (sample)
- 1x2 Fiber Splitter
- Detector

Design 2 “Beam Splitter” Design

UUT Radius	Coating	Total Power Collected upon Reflection
Infinity	100% mirror	$1.75\mu W$
500mm	100% mirror	$1.5\mu W$
50mm	100% mirror	$1\mu W$

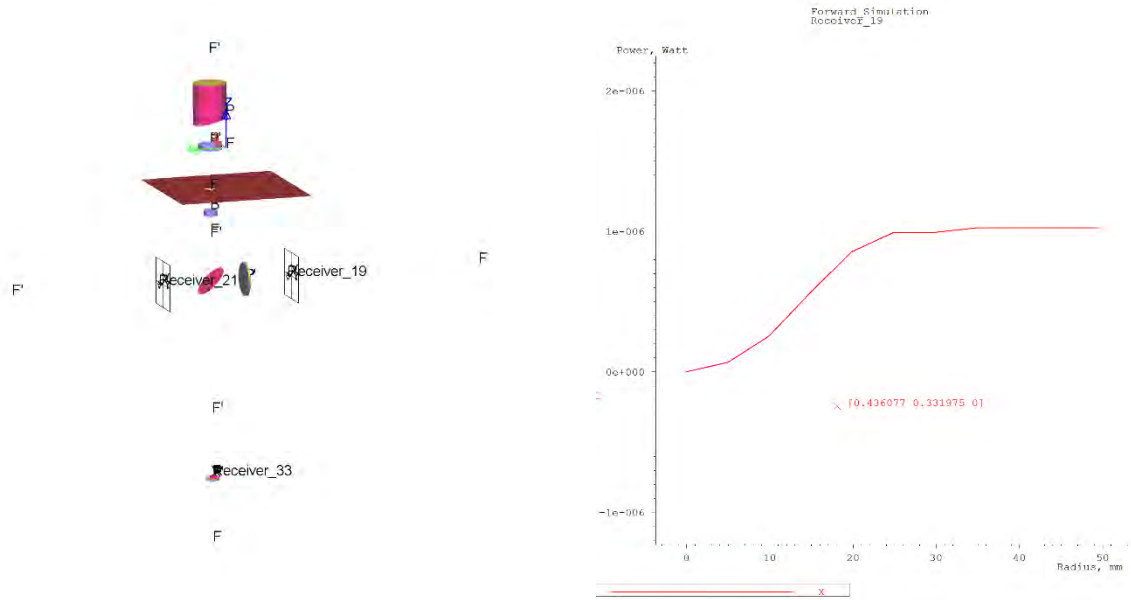

Polarizer

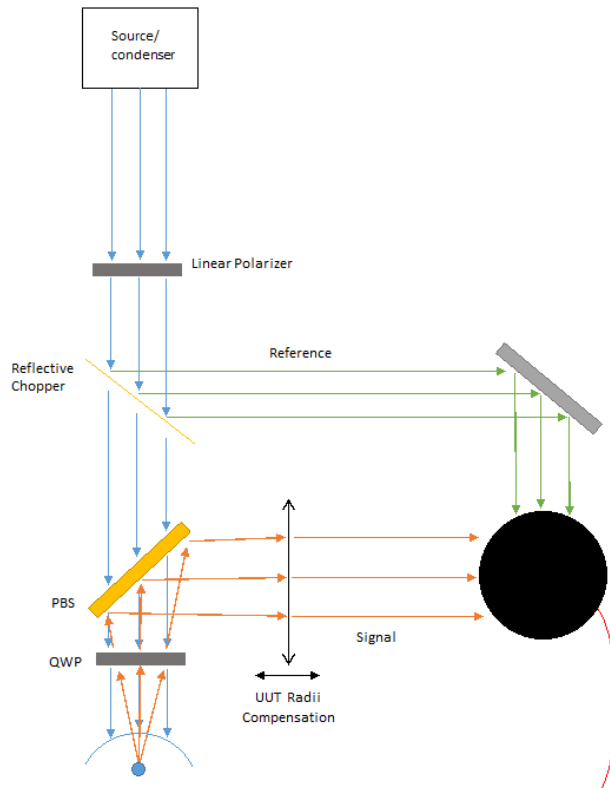

System Components

- Source
- Collimator
- Linear Polarizer
- Reflective chopper
- Reference mirror
- Polarizing Beam Splitter
- Quarter-wave Plate
- UUT
- UUT Radii Compensator
- Integrating Sphere

Integrating Sphere Design

In order to reduce the losses from the illumination system, it may be advantageous to encircle the beam divergence into an integrating sphere before spectrometer collection. This design would

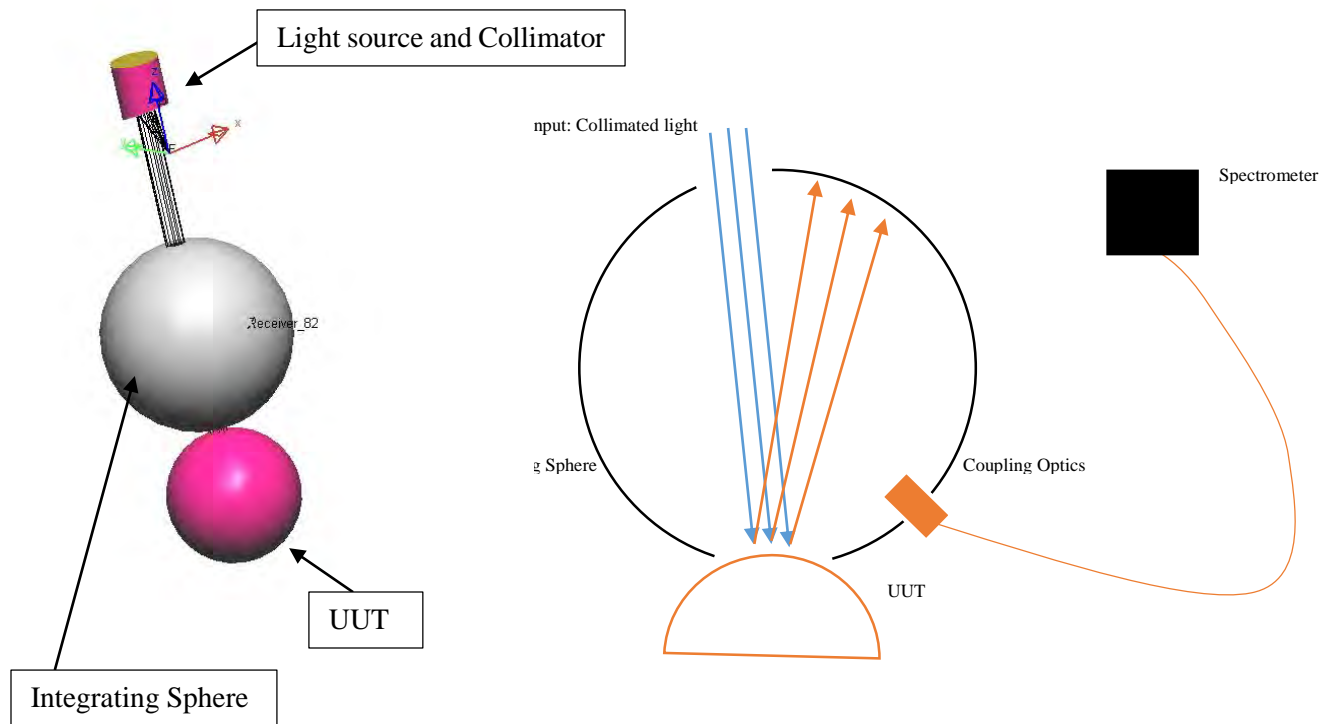

	5mmx5mm output window	10mmx10mm output window
70mm	7.6nW	31nW
100mm	5.4nW	33.7nW
200mm	6.2nW	28nW
250mm	4.1nW	38nW

Table 1: Total power collected vs output window. The divergence of the light after the UUT is not great enough such that it strikes the integrating sphere upon reflection into the sphere. This design, while relatively insensitive to radius change, it does not output enough power to record data.

rely on a very wasteful source such as xenon arc lamp which would accommodate for the losses incurred when fiber coupled.

Above is the initial results for the integrating sphere design. The table above shows how little light is collected using the integrating sphere design, the major downfall to this design is its dependence on off axis light to reflect light into the integrating sphere. Because light incident on the UUT is already non-normal incident, a beam condenser cannot be used in the design to increase the light on the UUT at 4 degrees, since the beam condenser inherently creates a diverging beam.

Most of the light reflects back from the UUT towards the collimation system, and not onto the scattering surface of the integrating sphere. There are two options to increase the amount of light which reflects onto the integrating sphere: increase the amount of light incident at 4 degrees (the largest allowed incident angle) or, alternatively the light could be made incident on the UUT from a larger off axis angle. The first is to increase the amount of light incident at the largest allowed incident angle (4 degrees) by using a beam condenser. However this is not possible for the reasons stated above. The second option (increase the maximum allowed incident angle) is possible, but not practical. By increasing the incident angle of the light to the absolute maximum of 8 degrees, the mechanical scanning system is constrained too much. Further the optical benefits would be marginal at best, since the system would still be sensitive to the radius of the UUT.

Appendix B

Product Information:

Sources

Energetiq EQ-99x



Specification	Value	Units
Price	\$11,080.00	Dollars
Wavelength Range	170-2100	nm
Typical Bulb Life	9,000	hours

- Most comprehensive source when considering all design needs
- Extremely stable output
- Brightest output over the widest spectral range
 - Allows for a much greater signal to noise ratio while making measurements
 - Could cause oversaturation of the detector, will need to consider spectral filtering of the source
- Very close to a “perfect” point source
 - Allows for highest degree of collimation

Overview	<ul style="list-style-type: none">• Spectral output from 170nm to 2100nm• Large collectable view angle – Numerical Aperture (NA): up to 0.47• Typical bulb life > 9,000 hrs.• Flexible optical interface for free-space optics (SM1 thread)• Various precision reflective coupling optics are available from Energetiq - call for details	
Physical Specifications	System Dimensions (H x W x D)	Weight
<ul style="list-style-type: none">• Lamp House• Power Supply	82.3 x 85.7 x 76.2 mm (3.2 x 3.4 x 3.0 in) 107 x 111 x 254 mm (4.2 x 4.4 x 10 in) (excl feet)	0.7 kg (1.5 lbs) 1.4kg (3 lbs)
Utility Requirements	<ul style="list-style-type: none">• Electrical: 100-240v, 50/60Hz, 2.5A• Cooling: Ambient air, no auxiliary cooling necessary• Nitrogen: Recommended purging for longest life & for DUV operation, Grade 6• Compliance: CE Mark, Class 1 Laser Product	
<small>Patent Numbers: US 7,435,982; US 7,786,455; GB 2,450,045; Other patents applied for.</small>		

Newport Xenon Arc Lamp



Specification	Value	Units
Price (Includes power supply/lamp housing)	\$12,800.00	Dollars
Spectral Range	190-2000	nm
Typical Bulb Life	n/a	hours

- Meets most design requirements
- Very bright and broad spectral output
- Spectral irradiance of the source is very unstable and drops off severely at the short end of our spectrum (around 200 nm)
- Far from being a “perfect” point source

Lamp Type	Xenon, UV-Enhanced
Lamp Wattage	1000 W
Effective Arc Size	1.0 x 3.0 mm
Bulb Diameter	38 mm
Horizontal Intensity	3000 cd
Lamp Current (A)	43.5 A
Lamp Voltage	23 V
Special Features	High power from small arc
Approximate Flux	30000
Approximate Brightness	400 cd mm ⁻²

Filmetrics LS-DT2 Deuterium Tungsten-Halogen Light Source



Specification	Value	Units
Price	n/a	Dollars
Spectral Range	190-2500	nm
Deuterium Lamp Life	2000	Hours
Tungsten-Halogen Lamp Life	1200	hours

- Very low light levels in the spectrum we are working in
- Stitching of spectra necessary because of the two sources
- Short bulb lifetime
- Most likely least expensive option (still waiting on quote from Filmetrics)

Spectral Radiance of 30W D2, 75W Xe, EQ99 and EQ1500

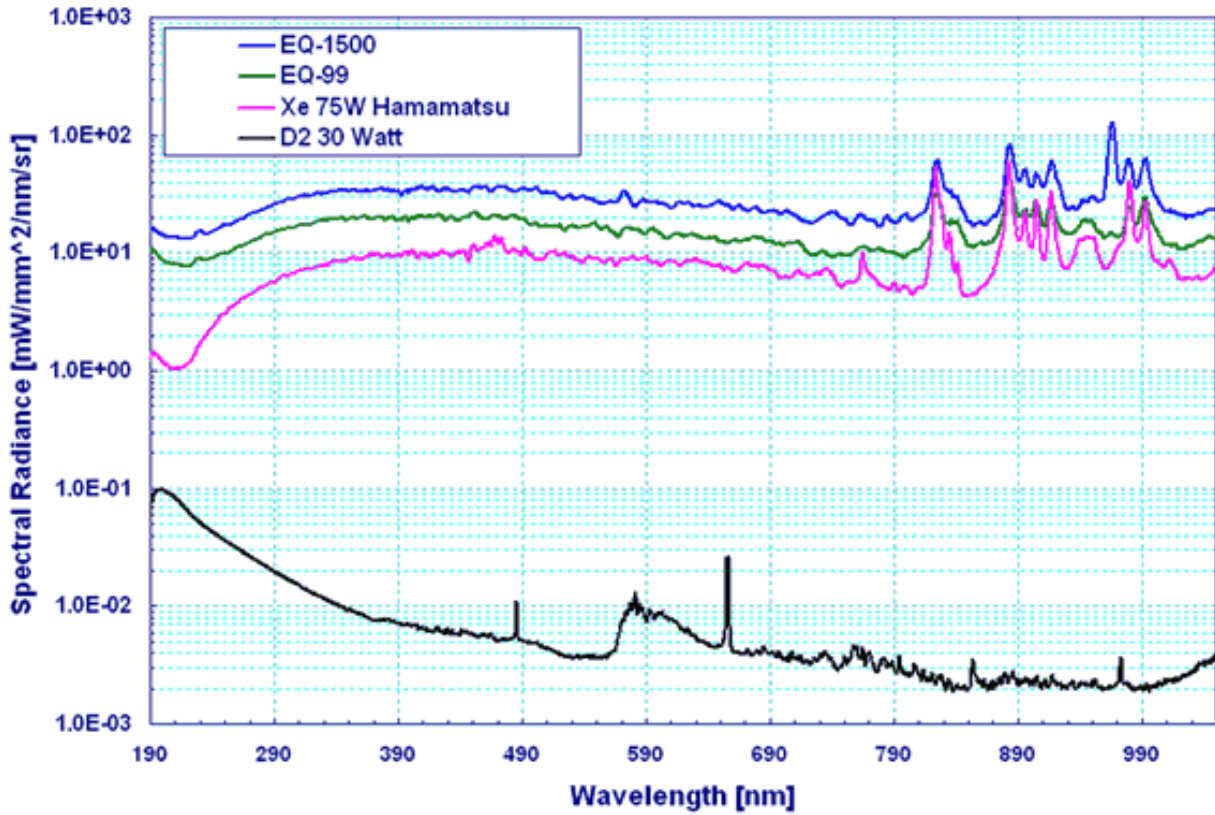

The above chart shows the spectral radiance of the three sources described above. Also included is the EQ-1500 which we are not including in our report. The chart was taken from Energetiq's frequently asked questions page.

Collimating/Focusing Optics

Newport Off-Axis Replicated Parabolic Mirror



Specification	Value	Units
Price	\$322.00	Dollars
Spectral Range	190-2000	nm
EFL	0.8	in
Coating	AL(MgF ₂)	n/a

- Recommended by Energetiq as coupling optics
- Reflective design eliminates large amounts of chromatic aberrations which are present in refractive elements
- Spectral reflectance begins to drop off towards the short end of our spectrum

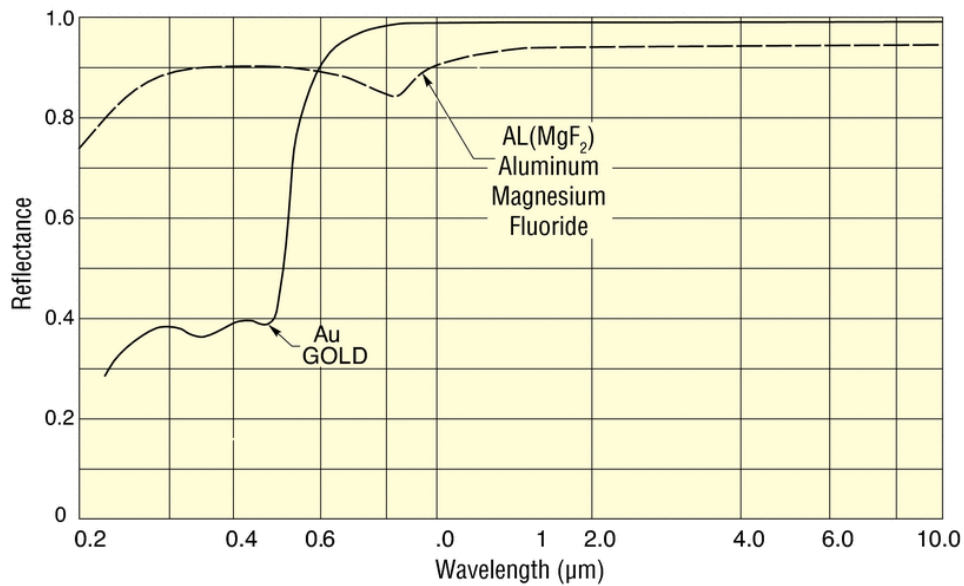

Edmund Optics UV-to-NIR Corrected Triplet Lens



Specification	Value	Units
Price	\$1,950.00	Dollars
Numerical Aperture	0.06	n/a
Wavelength Range	193-1000	nm
Effective Focal Length (EFL)	180	mm

- Refractive design form limits the performance of this piece in our application
- Lack of material choices in the DUV makes color correction difficult over a wide spectrum
- Software may be able to account for chromatic shift in focal length

Effective Focal Length EFL	193 - 400nm	
	Chromatic Shift	RMS Spot Size
36mm	1.8mm	240 μ m
45mm	1.1mm	88 μ m
90mm	2.0mm	64 μ m
135mm	1.6mm	49 μ m
180mm	1.4mm	46 μ m

Spectrometers

Filmetrics F40-UV



Specification	Value	Units
Price	n/a	Dollars
Spectral Range	190-1100	nm
Film Thickness Range	4-40.	nm

- Includes software for analyzing thickness of films (see figure below)
- Local support of Filmetrics staff
- Will work well with Energetiq source if spectrum can be filtered

Common Windows commands for saving, opening, and printing your measurements.

Live video showing measurement location using SampleCam accessory.

Measured and calculated spectra are displayed.

Color can be displayed on most systems.

Results are available in seconds or less.

Hundreds of thin-film recipes can be saved.

Ocean Optics Maya2000 Pro



Specification	Value	Units
Price	\$7,000.00	Dollars
Spectral Range	190-1100	nm
Spectral Resolution	0.44	nm

- Meets all project requirements (spectral resolution, spectral range)
- Will need to write custom software for analyzing thin film thickness
 - Although this would require more work it would allow Optimax a higher degree of customization in their software

Spectroscopic	
Spectral range (detector response):	~165-1100 nm (S10420)
	~400-1180 nm (S11510)
Optical resolution (FWHM):	Depends on grating groove density and slit size (multiple options available)
Signal-to-noise ratio at full signal:	~450:1
Dynamic range:	15000:1 (typical)
Integration time:	7.2 ms-5 seconds
Fiber optic connector:	SMA 905 to 0.22 numerical aperture single-strand optical fiber

Beam Splitters

Thorlabs CaF₂ Polka Dot Beam Splitter



Specification	Value	Units
Price	\$525.00	Dollars
Spectral Range	180-2000	nm
Material	CaF ₂	in
Transmission/Reflection	50/50	percent

- Only commercially available option (that we are aware of) which operates over our spectral region
- Need to make sure spot size on beam splitter is large enough in order for “Polka Dots” to be effective

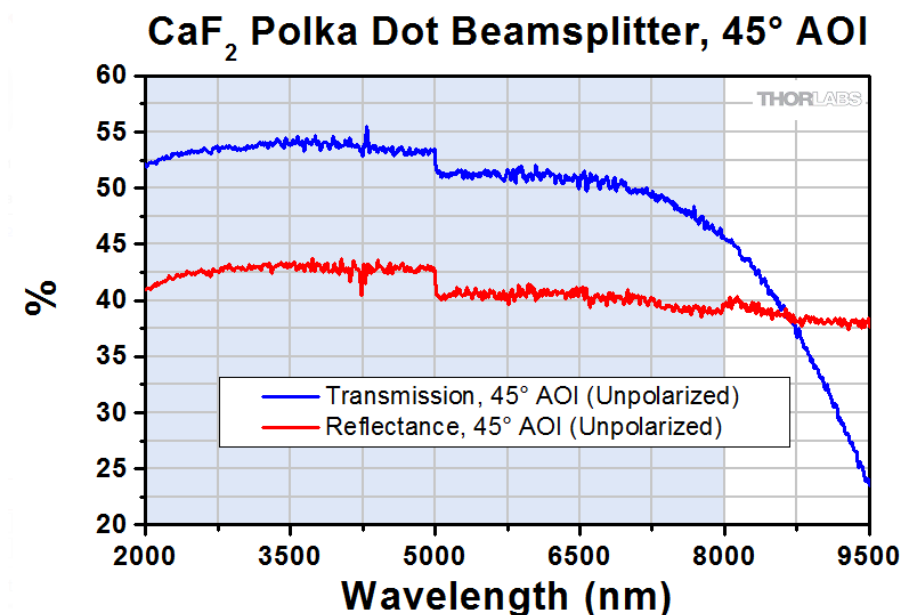

Edmund Optics Polka Dot Beam Splitter



Specification	Value	Units
Price	\$115.00	Dollars
Spectral Range	250-2000	nm
Material	Fused Silica	in
Transmission/Reflection	50/50	percent

- Product does not cover full spectral range
- Material choice limits the application of this beam splitter

Diameter (mm)	12.7
Dimensional Tolerance (mm)	+0.0/-0.5
Clear Aperture CA (mm)	9.7
Minimum Aperture (mm)	2
Thickness (mm)	1.5
Surface Quality	80-50
Wavelength Range (nm)	250 - 2000
Angle of Incidence (°)	0 - 45
Parallelism (arcmin)	<3
Center to Center Spacing (mm)	0.15
Substrate	Fused Silica
Reflection/Transmission Tolerance (%)	±5

Edmund Optics DUV ReflX Objective



Specification	Value	Units
Price	\$2,499.00	Dollars
Spectral Range	150-1100	nm
Material	Aluminum	in
Numerical Aperture*	0.28	n/a

- Reflective design offers wide spectral band with no chromatic aberrations
- Objective will be used in “reverse” with the low NA side facing the UUT
- Greater than 88% reflectance over entire spectral region

Primary Magnification PMAG	15X
Numerical Aperture NA	0.28
Working Distance (mm)	23.75
Focal Length FL (mm)	13.3
Field of View, 1/2" Sensor	0.43 x 0.32mm
Field of View, 2/3" Sensor	0.59 x 0.44mm
Transmitted Wavefront, P-V	0.25 λ
Obscuration (%)	27
Entrance Pupil (mm)	7.4
Aperture Diameter (mm)	8.5